

Fashion Freaks

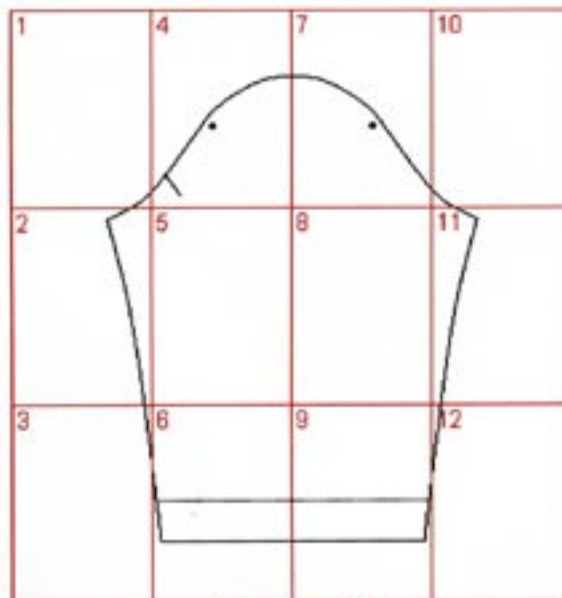

MÖNSTERDELAR

JACKA I KAVAJSTIL FÖR KVINNOR - NORMAL, RAK ÄRM



jacka i kavajstil
rak ärm
normal sleeve

Så här sätter du ihop A4-bladen till ett helt mönsterark för en rak äm.

Varje sida i den här pdf-filen innehåller en numrerad del av detta mönster.

Du sätter ihop dem genom att matcha 'kant-hakarna' mot varandra.

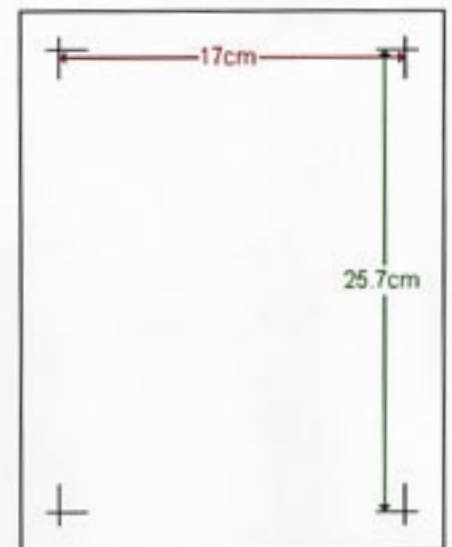

Kom ihåg att skriva ut sidorna på A4-papper (210 x 297 mm) så att måtten på ditt mönster blir korrekta.

Mät avståndet mellan 'kant-hakarna' för att vara säker att du får rätt storlek. Avståndet är (170 x 257 mm)

Women's Jacket 1: Sleeve - Normal (1 of 12)

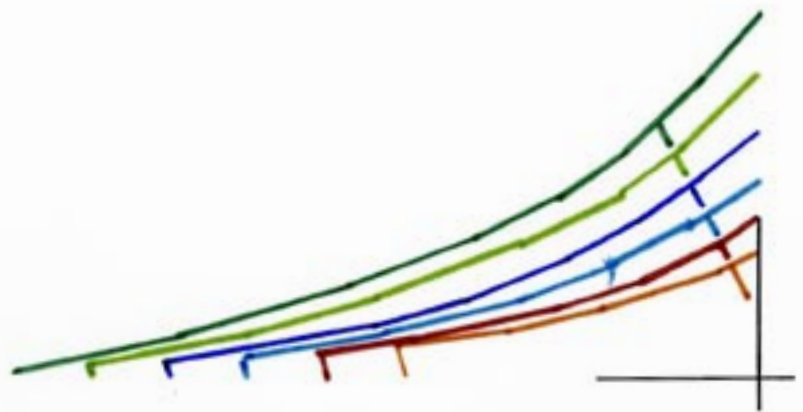
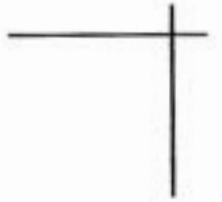

Women's Jacket 1: Sleeve - Normal (2 of 12)

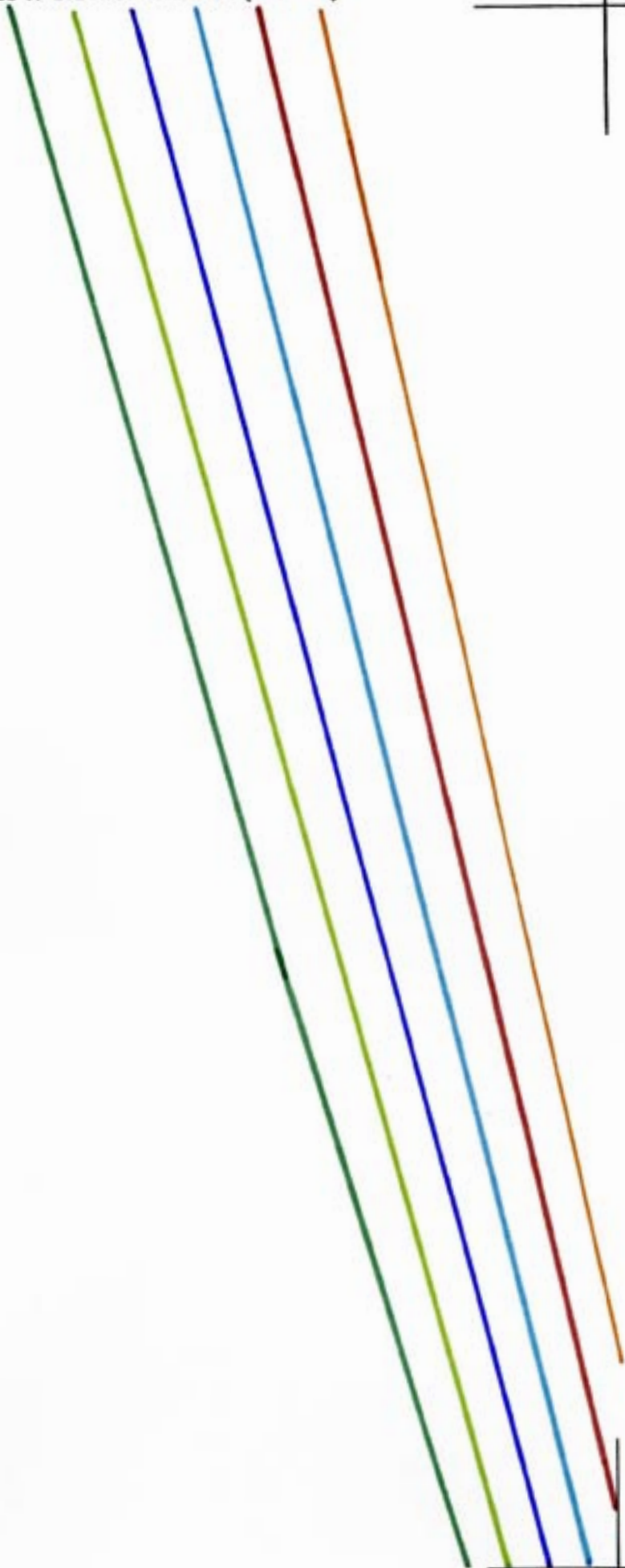

Women's Jacket 1: Sleeve - Normal (3 of 12)

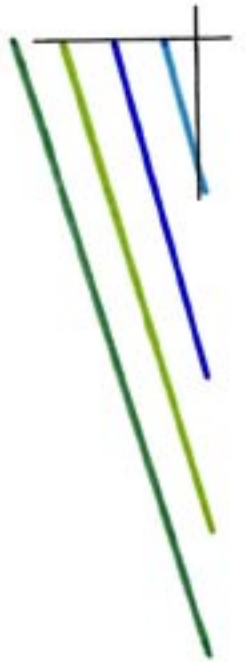

Women's Jacket 1: Sleeve - Normal (4 of 12)

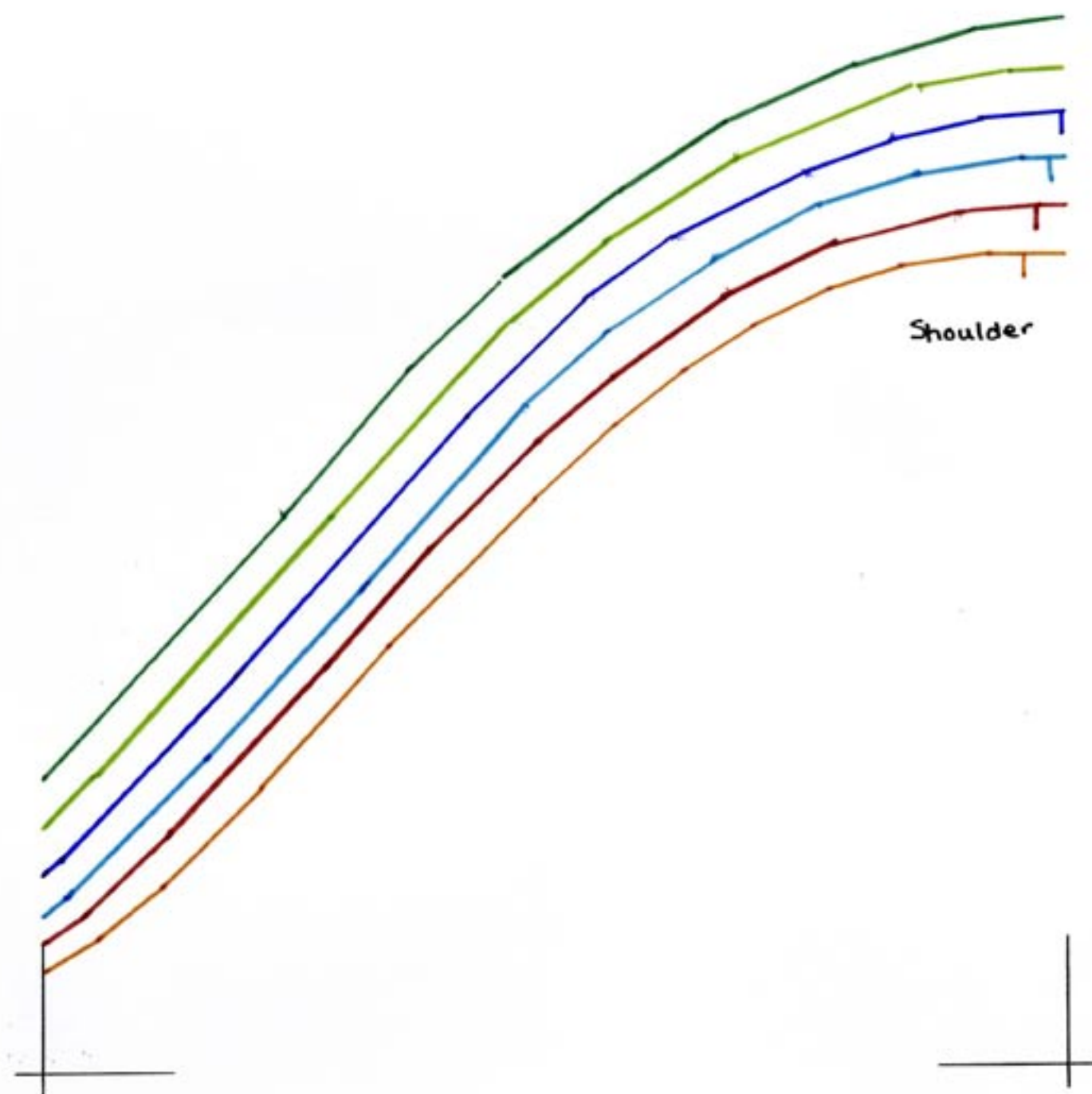

Women's Jacket 1: Sleeve - Normal (5 of 12)



Women's Jacket 1: Sleeve - Normal (6 of 12)



Cut here for Sleeve with wristband

Cut here for Sleeve without wristband.

Women's Jacket 1: Sleeve - Normal (7 of 12)

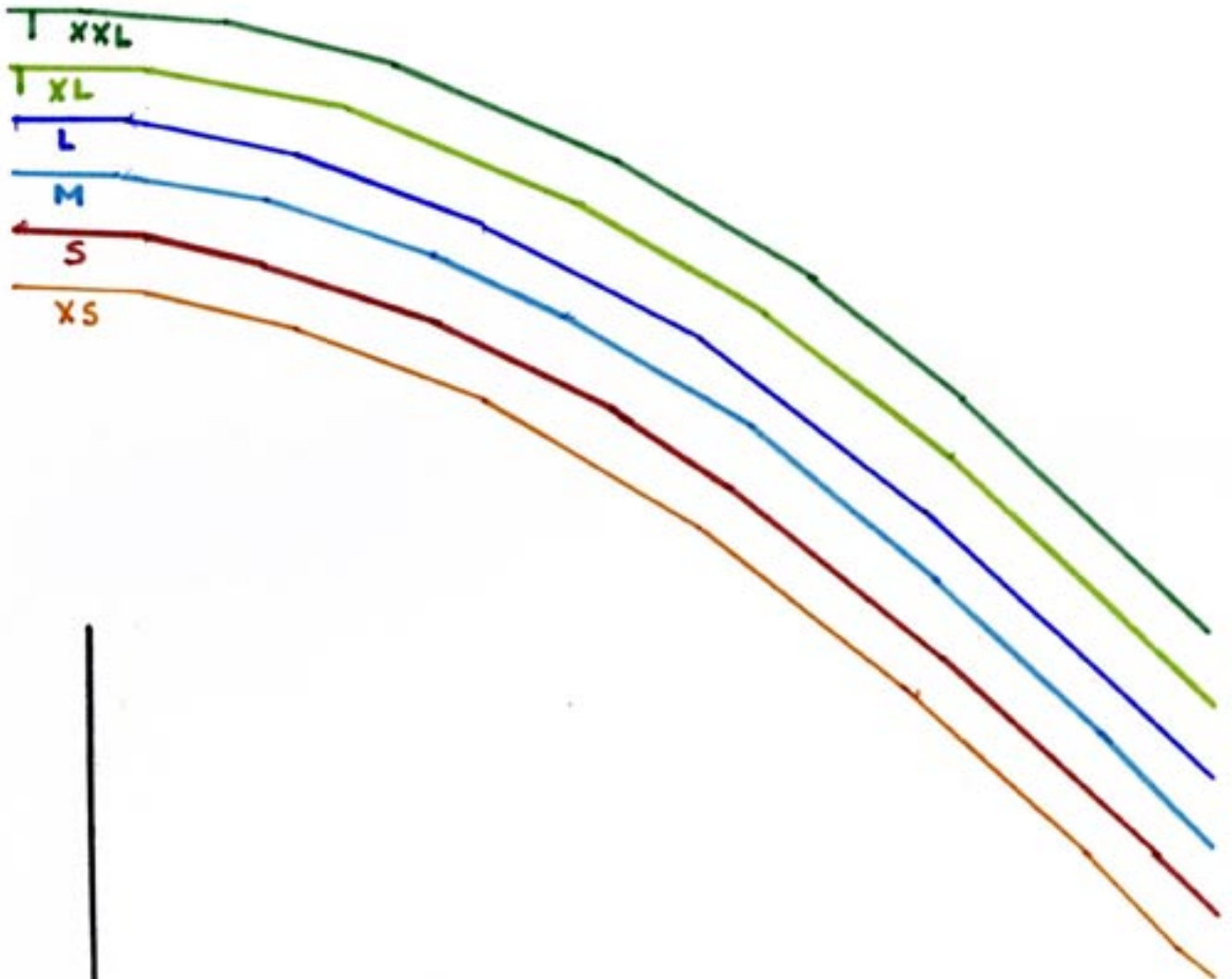

Women's Jacket 1: Sleeve - Normal (8 of 12)



Run of Fabric



Women's Jacket 1: Sleeve - Normal (9 of 12)



Women's Jacket 1: Sleeve - Normal (10 of 12)

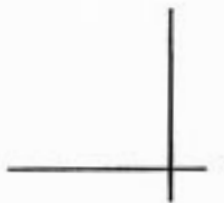
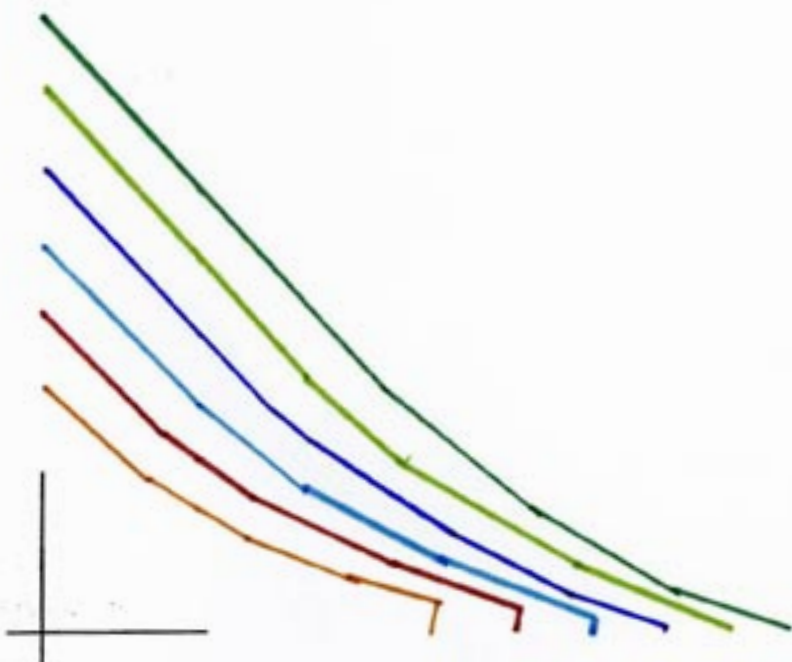

Women's Jacket 1: Sleeve - Normal (11 of 12)

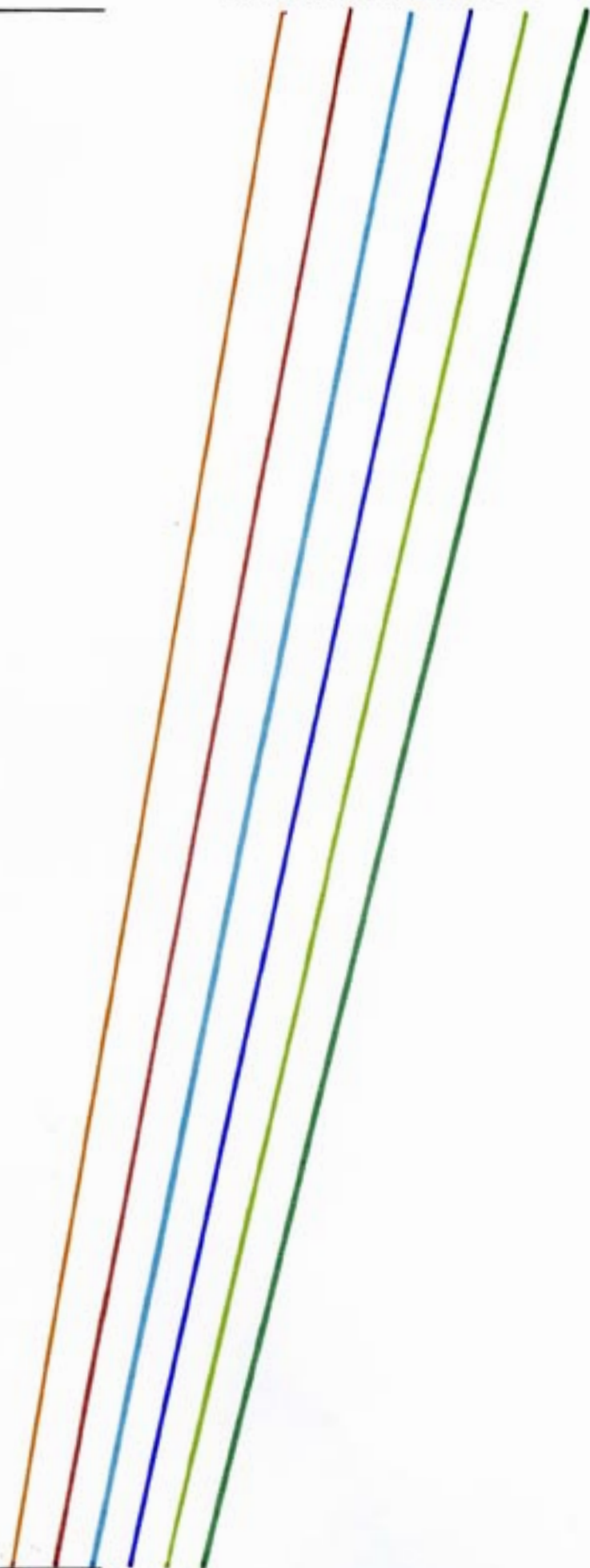

Women's Jacket 1: Sleeve - Normal (12 of 12)

